

Alpha C852

ALPHA PLUS MODEL ENGINE INSTRUCTION MANUAL SAFETY INSTRUCTIONS AND WARNINGS:

Alpha Plus model engines are not a toy but are highly powerful micro engines. If it is misused or abused, it could harm you or others. As the owner of the engine, you are responsible for the safe operation. Please carefully go through this instructional manual, if not properly handle or treated, it can be dangerous and cause damages or minimized the engine performance.

*WARNINGS : These cover events which might involve series (in extreme circumstances, even fatal) injury.

NOTES:

- 1 Must be over 14 years of age.
- 2 Modifying the engine is prohibit.
- 3 Match exhaust pipe set is recommended for best performance. Please check Alpha Plus version pipe set.
- 4 Alpha Plus would not guarantee the operation safety on act of self modify Alpha engine.
- 5 This engine must not be used beyond model purpose.
- 6 This engine can only be used in outdoors. Never operate the engine in an enclosed space. The engine exhausts deadly carbon-monoxide, therefore, always run the engine in an open area only.
- 7 Do not run such as residential areas and hospitals, where loud noises can disturb others.

INTRODUCTION :

Alpha model engines are designed and manufactured by highest required precision machines with the years RC industry experiences. In the engine package has the explorer chart for you to know the components of the engine, and also can be the guideline to choose for standard and optional parts. Following the instructions step by step can help you

- 1 Getting the best performance and longevity engine.
- 2 Avoiding the damage of engine due to the incorrect maintenance.
- 3 Ensuring the safety of yourself and others.

INITIAL STEPS :

- 1 Place/secure a proper clutch system on the front of the engine crankshaft. (Please check the model car instruction manual to see if it's able to fit in.)
- 2 Place/secure an exhaust pipe set to the rear engine exhaust valve.
- 3 Place/secure a glow plug, which with correct heat ranges in the cooling head bottom.
- 4 Place/secure the engine on the chassis and properly match clutch bell gear to spur gear.
- 5 Connect the fuel tube line from tank inlet to muffler pressure nipple and from tank outlet to carburetor inlet.
- 6 Connect the carburetor ball linkage to the throttle servo. Make sure pulls in/out smoothly.

STARTING AND STOPPING THE ENGINE:

Starts the engine: Put the engine on the chassis, and then put the chassis on the starting box. Make sure the flywheel should match to the starter rubber wheel, and the flywheel spins on the counter clockwise direction. Use battery power at 1.5-2 vlot glow plug igniter to tune up the plug. Bump start the engine. Make sure remote system power turns ON. Then trig the trigger to open throttle to 50% rapidly. Adjust till idle maintain stable.

Stops the engine: Close the throttle to idle speed and shut it off completely. Use a plastic or asoft stock to stop the flywheel. Remember, the engine generates considerable heat, therefore do not use hands to touch such as engine, muffler, flywheel, cylinder head or exhaust pipe till it has cooled or completely stops, otherwise it may cause a serious burn.

Carburetor Function and Adjustment :

High Speed Needle(HSN): To Adjust the top speed. (Air-fuel ration when full throttle opened)
Factory setting: HSN flush with housing, then counter clockwise 2H.

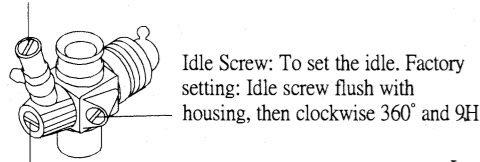

Medium Speed Needle(MSN):
To adjust the speed up.
Factory setting: MSN flush with housing.

Low Speed Needle (LSN): To adjust the idle and the speed up when starts running. Factory setting: LSN flush with housing, then counter clockwise 2H.

Adjustment: Using the clock as image

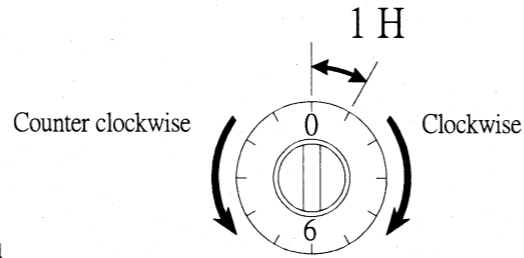

Remember not to turn over 2H every time while tuning.

High Speed Needle :

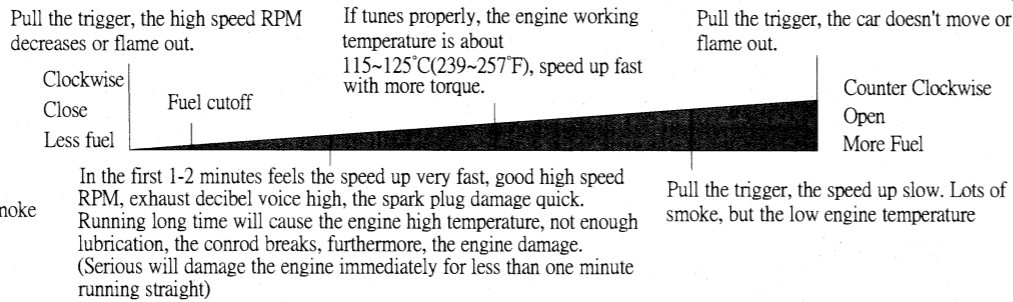
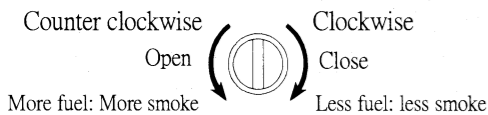

Low Speed Needle:

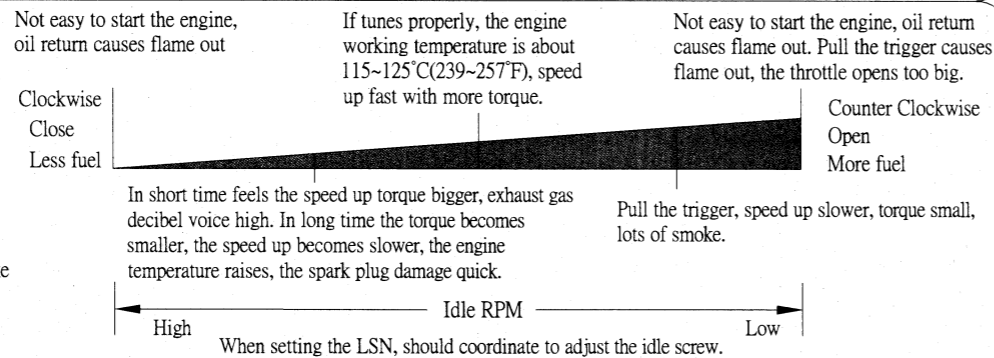
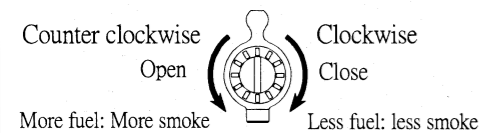

Idle Screw:

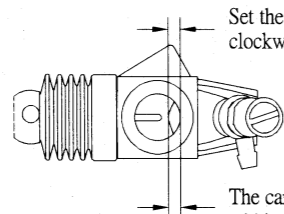
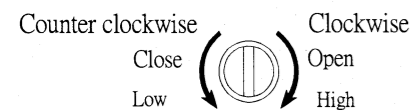

Set the throttle opening 0.5-0.6mm. to let the idle screw flush with housing, and then clockwise 360° and 3H.

* The LSN should be coordinate, therefore, let the LSN flush with housing, and then counter clockwise 2H.

The carburetor setting is the break-in position setting. factory setting: throttle opening 1.0mm width. (Idle screw flush with housing, and then clockwise 360° and 9H.

Carburetor Adjustment:

Please follow underneath carburetor setting steps.

1. High Speed Needle Setting (HSN).

Check the needle setting is the factory setting (HSN flush with housing, then counter clockwise 6H). Smoke is one of the easy ways to generate the HSN. When the engine rpm increases smoothly during acceleration, should have visible light smoke comes out. If there's no smoke or very few smokes, should stop running immediately, and then re-adjust the needle, also check the temperature. Running in the straight line back and forth with the full throttle open, to investigate the car speed and the engine temperature, till the engine temperature is 105~115°C (221~239°F). When tunes HSN, remember turns only 0.5H~1H every time.

* Check "High Speed Needle" figure to see the engine reflection.

* NOTE: Do not tune too lean, it may cause the high temperature. This will let the engine lost its mechanical properties, furthermore, will affect the performance. Very few smoke or no smoke means the main fuel valve is too small, keep running will cause the high temperature. Not enough lubrication, will damage the engine. More seriously, it will cause the conrod breaks, this will damage the engine immediately. Fuel is not only supply the burning power, but also supply the lubrication and the cooling down function.

2. Low Speed Needle Setting. (LSN)

After setting the HSN, please do remember the idle setting (set the throttle opening 0.5-0.6mm, to let the idle screw flush with housing.) should correspond with the LSN setting (LSN flush with housing, then counter clockwise 6H). Then runs the car in the straight line several times, and then completely stops the car, close the throttle, idle for 5 seconds, then accumulating speed up with the throttle fully open. If the engine comes out lots of smoke and the car cannot speed up rapidly or even flame out. This might because the idle gas mixture is too rich. Should turn the LSN 0.5~1H clockwise. If accumulate the engine with the throttle fully opened, it instant speed up but flame out suddenly, this might because the idle gas mixture is too lean. Should turn the LSN 0.5~1H counter clockwise.

*Check "Low Speed Needle" figure to see the engine reflection.

3. Idle Setting.

If close the throttle, idling is too fast, counter clockwise the idle screw to let the throttle valve smaller for decreasing the rpm.

If close the throttle, idling is too slow, clock wise the idle screw to let the throttle valve bigger for increasing the rpm.

*Check "Idle Screw" figure to see the setting. Set the throttle opening 0.5-0.6mm, to let the idle screw flush with housing.

4. Check Temperature.

After done step 3, re-set the HSN and adjust the engine temperature. Temperature between 115~125°C (239~257°F) means the setting complete.

The Best Carburetor Setting:

During high speed running, the light smoke is visible, with the acceleration, the engine rpm increase smoothly. Keep working on step 1~3 patiently, until the engine the engine responds to the throttle valve quickly and positively. Please note, if the fuel/air mixture is too lean, the engine will become overheat, and might cause the damage. We would recommend to set the HSN and LSN in rich in order to keep the best rpm setting as a safety measure. After the setting complete, needs to run completely 1-2 fuel tanks, test the temperature. Then continue fine tuning from the step 1~3 to keep the best performance.

NOTE:

The carburetor needle setting position will be different because of the following things: the usage of the spark plug, the usage of silencer, the fuel quality, and the content of the nitromethane. Generally, if the fuel content of nitromethane is less, the power will be smaller, and the temperature will get higher when running. Therefore, if you use the fuel containing less nitromethane, please remember to close further the needle valve in order to get more power. And this will cause the lubrication decrease, thus causes the high temperature and reduce the engine service life.

Fuel:

Would recommend using the high quality of fuel in order to get the better performance. The high quality fuel lubrication can protect the rotating parts to reduce the wear possibility. Thus to extend the engine service life. 25~30% nitromethane fuel is recommend. (if use <20% of fuel, please reduce 0.1mm head shim)

Running-In Process:

C852 carburetor setting is the run-in position setting, please use the following steps to complete the break in process.

1 Make sure the engine mounted on the car correctly.

2 Full fill the tank. Put the car on the starter box, open half of the throttle, and then start the engine. (25~30% nitromethane is recommend, if use <20% nitromethane, remember to reduce 0.1mm head shim)

*Note: Do not idling high speed on the starter box when the break in process hasn't fully completed. This will cause the damage of the engine, and furthermore, the crankcase will break, and so does the conrod.

3 Static Running-In: Adjust the idle until the throttle half opened. The tire states between run and not run. The opening throttle valve is about 1mm width. Run the engine about 500cc in rich.

4 Motion Running-In: Also called running-in under load or hot running-in. With throttle power between 50-80%, run the car in a pattern "8" style continuously in the specific track or the flat ground at low and med speed for 2-4 tank. Remember to check the engine after running out every tank of oil. The engine temperature should be 90~110°C(194~230°F). After running every 500cc, let the engine cooled, loosen the spark plug 2 turns, then use the finger to turns the flywheel for 360°, if feels the flywheel stuck, then repeat the step 4, then runs another 2-4 tanks, then check once again. About 2-3 litter runs out, the break-in process is completed.

Note:

The "Running-In Process" should do once again if replace any major components, such as piston sleeve, bearings, crankshaft or the fuel, especially changed to high nitro fuel.

Maintenance:

Every time after using the engine, please drain out all remaining tank fuel, and then energize the spark plug to try restarting the engine, in order to burn out all the remaining fuel in the engine. Repeat these processes till the engine fail to start up. Remember to do this process when the engine is still hot, otherwise the remaining fuel will eventually cause oxidation (rust), hence erosion the engine. Therefore, please make sure there has no fuel left in the engine. The usage fuel is not reusable, do not pour the usage fuel back to the fuel bottle. Once the fuel pour out of the fuel bottle, in addition, the fuel continually contacts air, this will change the fuel contents and also will reduce the fuel quality. Components such as bearings, crankshafts, and conrod would be easily get oxidized by using the bad quality fuel. If you found the engine get oxidized, stop using the current fuel, and use oil with methanol mixture to running in the engine.

Cleaning:

Please use methanol or a household detergent by a small brush to clean the external part of the engine. Do not use gasoline to do this. Methanol and engine fuel are highly flammable. Keep these away from open flame, excessive heat, sources of sparks or anything else which might ignite it. Do not smoke and do not allow other smoker smokes near it.

Checking:

Remember always set the piston position in the top dead center before taking out the backplate cover, otherwise the piston skirt would get stuck in the backplate curve. If taking off the backplate with the piston skirt stuck, the piston will break out.

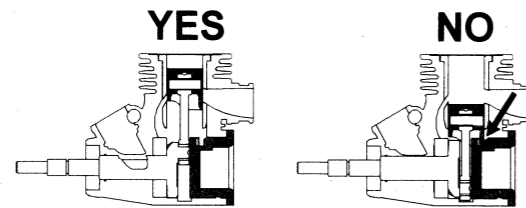

Running in a long time period will let the components getting wear, it would cause the engine not perform well. Would recommend to investigate the following, and change the components if possible.

1. Unusual engine sound. (For example the metal percussion)
2. Easily over heat.
3. Extremely dropping power, or no power when pull the trigger.
4. Unstable idle, or flame out.
5. Flame out when running.
6. Unusual engine running, or when pull the trigger the engine suddenly cannot run or when pull the trigger the engine flame out immediately. Please investigate the underneath components and the fuel supply system as well.

Fuel tank, tube, fuel filter get stuck, so cannot supply fuel successfully or only a few fuel supplies.

1. In the worst-case scenario, the engine would be unable to start.
2. In the slight-case scenario, due to the less fuel supply, the engine RPM and the temperature would become higher, and the smoke would be very few. If has the foreign material inside, the
3. engine speed would become unstable when runs the engine.

Too many fuels in the engine.

1. The engine would be unable to start.
2. Too many fuel would cause the compression pressure too high, therefore the crankshaft could not rotates smoothly (In order to solve this, should take off the spark plug, use rags to cover he spark plug hole, and then start up the engine on the start box to let the over fuel flow out from the spark plug hole, then lock back the spark plug. Remember, before taking off the spark plug, always clean the dust around it to avoid the dust get into the engine.)

Spark plug breaking or aging.

1. The engine would be unable to start.
2. Unstable idling.
3. Cannot keep on the low RPM, flame out immediately when tunes idling low.
4. Decreasing torque.
5. Accelerate becomes slow.

No battery of spark park igniter. The engine would be unable to start.

Incorrect tuning of carburetor.

1. The throttle opening is too small, so the engine would not be easy to start up. Oil return causes flame out.
2. Low speed needle tunes either too big or too small, therefore the engine would not be east to start up. After braking, the oil returns causes flame out.
3. High speed needle tunes either too big or too small, therefore the engine would not be east to start up. After pulling the trigger, the engine flames out.

Parts such as clutch shoe, spring, clutch bell, bearings damage.

1. When starts up the engine on the start box, the tire would follow the idle to start to rotate, but once the tire stops, the engine flame out immediately..
2. Flame out when brakes the car.
3. Tunes the low speed needle, but the engine reaction is not obvious. Pull the trigger, the accelerate becomes slow, and the torque drops down.

Wearing/damage of the piston sleeve.

1. The compression ration decrease, torque decrease, and the accelerate becomes slow.
2. Unstable idle would cause flame out easily.
3. Good high speed, but the accelerate of low and middle speed is not good.
4. The spark plug damage quickly.

Wearing of the conrod.

1. Unusual engine sound. (For example the metal percussion)
2. The compression ration decrease, torque decrease, and the accelerate becomes slow.
3. Unstable idle would cause flame out easily.

The conrod replacement: would strongly suggest changing a new conrod after running 2 gallons. We wouldn't compensate or warrantee if the conrod replacement does not follow our suggestion. Please note, after changing a new conrod, should use the slow-medium speed to run for 2-3 fuel tanks and then accelerate slowly. If runs the the engine in high speed after changing a new conrod, it will cause the conrod damage quickly.

Clogging of the air filter foam.

1. More Fuel, more smoke, acceleration becomes slow, high speed becomes slow, temperature becomes decreasing.
2. Torque becomes small.

Always use the air filter.

The air filter is one of the important part, it can avoid the dust get into the engine, besides it can not only assist the engine works smoothly but also can extend its usage life. So please remember, always set up the air filter before running the car. The air foam should have the filter oil all around the foam, in order to have the best filter effectiveness. If not using the air filter, the components such as piston, bearings, crankshaft would be wore with the dust, in the worst-case scenario, the conrod would break, the engine would be unable to start. The high quality Alpha air filter housing with foam (AP-X000020) could filter tiny dust to extend the engine usage life.

Warranty Exclusion:

Please note, the engine would need the owner's maintenance and checking carefully. Factory warranty will be exempt for the following:

- Engine damages due to install the damaged bearings, conrods, or couplings on the engine.
- Engine damages due to operate against the instruction.
- Engine damages due to use the improper fuel, pipes, air filter or other accessories.
- Engine damages due to let the dust or dirt get into the engine.
- Engine damages due to modification the internal or external structure of the engine.
- Engine damages due to the aging, wearing, or breaking cause by normal running.
- The moving parts damages due to the incorrect carburetor tuning or the incorrect gearbox working.

Dimensional Drawing:

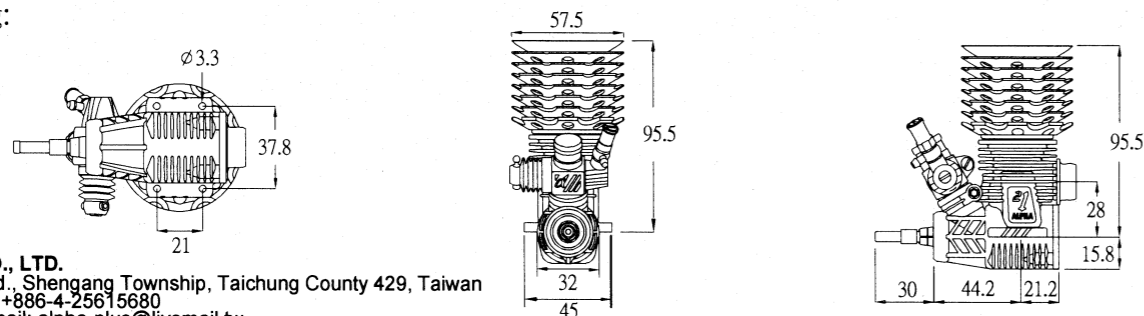

ALPHA PLUS MODEL CO., LTD.
 Add.No.110-8, Minsheng Rd., Shengang Township, Taichung County 429, Taiwan
 Tel: +886-4-25625478 Fax: +886-4-25615680
 Web: www.alpha-rc.com Email: alpha-plus@livemail.tw

In order to ensure the high quality and reliability of the products, Alpha Plus Model Co., Ltd reserve the right to make changes without any notice. If you have any questions, please email to alpha-plus@livemail.tw



21-C852

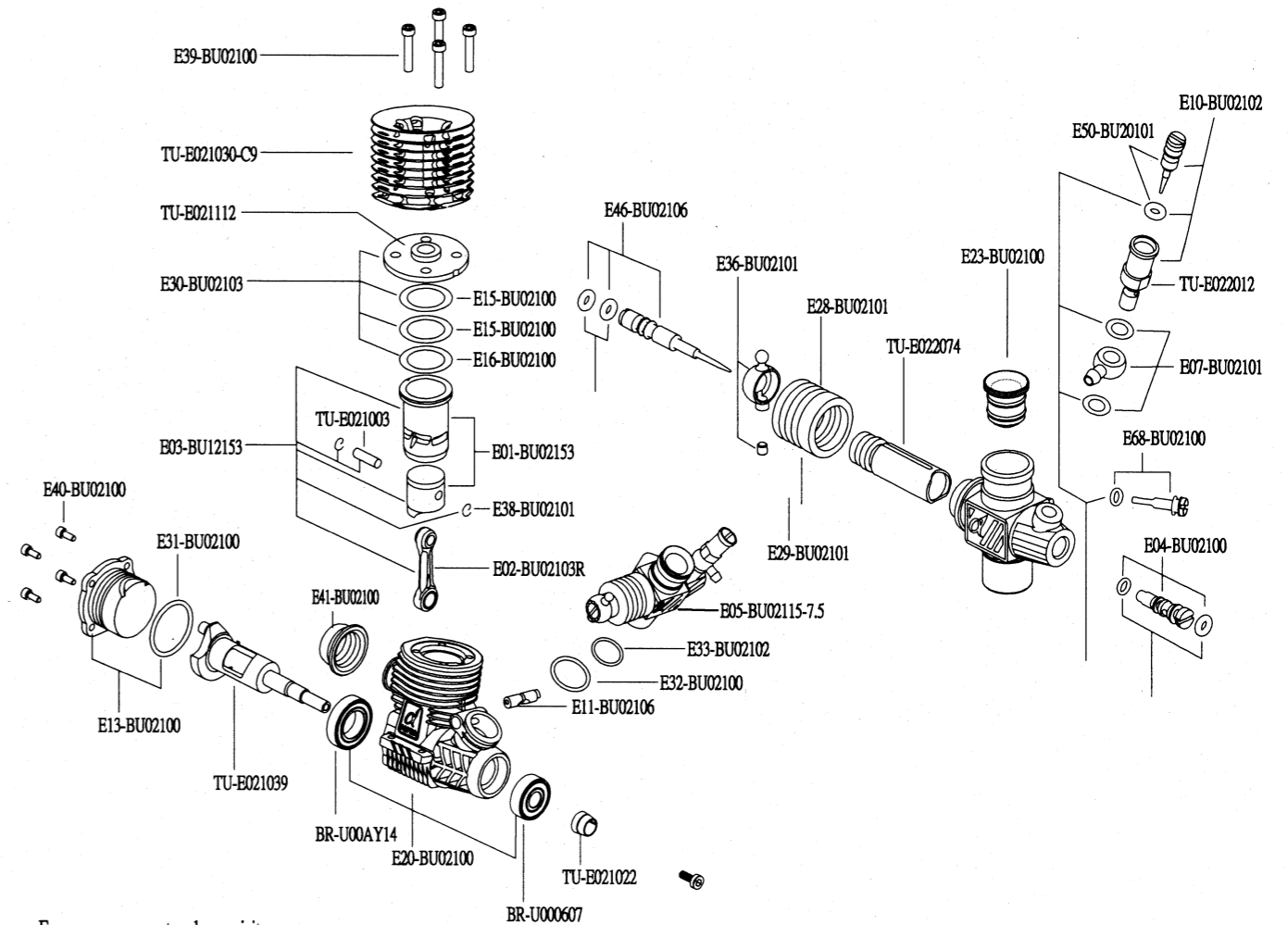

For more spare parts, please visit
www.alpha-rc.com

We reserve the right to make changes without notice.
 04/18/2023

Part No.	Description
E36-BU02101	Carburetor Ball Linkage with Screw
E38-BU02101	Piston Pin Clips (4pcs)
E39-BU02100	Cooling Head Screw (4pcs)
E40-BU02100	Backplate Cover Screw (4pcs)
E41-BU02100	Rubber Adaptor for Manifolds (2pcs)
E46-BU02106	Low Speed Needle with O-Ring
E50-BU02101	High Speed Needle with O-Ring
TU-E021039	21 Crankshaft
E68-BU02100	Idel Adj. Screw with O-Ring
TU-E021003	Piston Pin
TU-E021022	Flywheel Collect
TU-E021030-C9	Cooling Head
TU-E021112	Turbo Button Head 21
TU-E022012	Main Needle Socket
TU-E022074	Carburetor Throttle

Part No.	Description
BR-U00AY14	Rear Ball Bearing
BR-U000607	Front Ball Bearing
E01-BU02153	Set Precise Piston/Sleeve 5+2PT
E02-BU02103R	Connecting Rod 21
E03-BU12153	21 Complete Set Precise Piston/Sleeve/Rod 5+2PT
E04-BU02100	Medium Speed Needle Set
E05-BU02115-7.5	21 Carburetor
E07-BU02101	Fuel Supply Nipple Set
E10-BU02102	High Speed Needle Set
E11-BU02106	Carburetor Retainer
E13-BU02100	21 Backplate Cover with O-Ring Set
E15-BU02100	Head Shim 0.1mm (5pcs)
E16-BU02100	Head Shim 0.2mm (5pcs)
E20-BU02100	21 Pro Crankcase Set
E23-BU02100	8mm Velocity Carburetor Insert
E28-BU02101	Dust Protection Bellows (2pcs)
E29-BU02101	O-Ring Kit for Carburetor
E30-BU02103	21 Turbo Button Head Set
E31-BU02100	21 Backplate Cover O-Ring (5pcs)
E32-BU02100	21 Carburetor Lower O-Ring (5pcs)
E33-BU02102	21 Carburetor Upper O-Ring (5pcs)